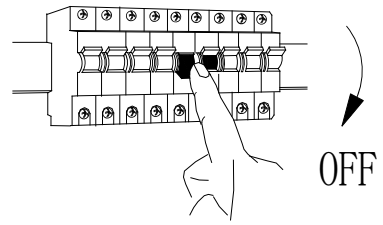
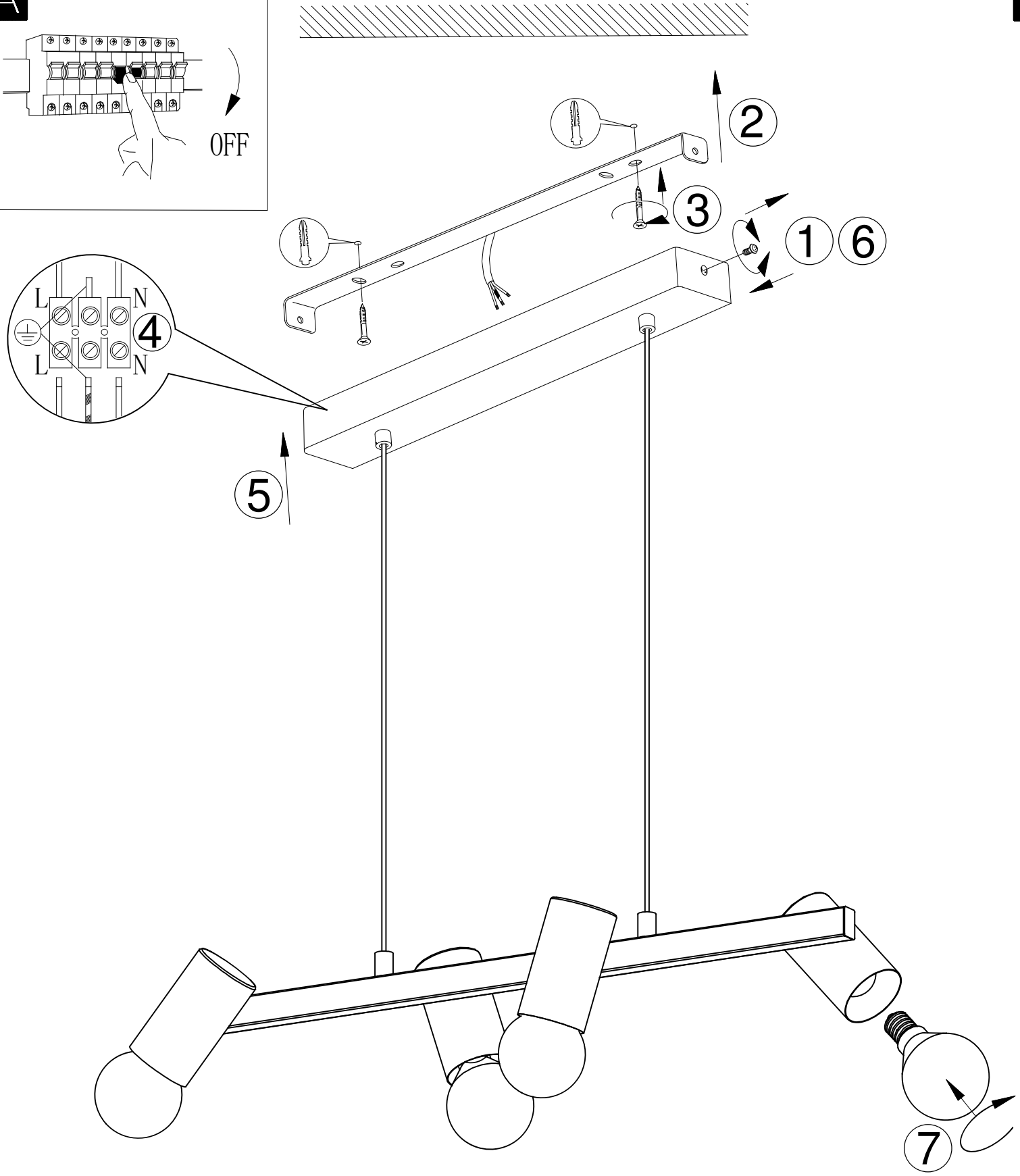
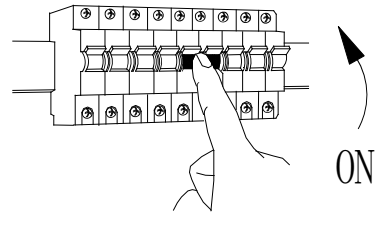

**A****B****C**

BLA98686  
 WWW.Eglo.com